



Investor Presentation

January 2024

Disclaimer

This presentation contains forward-looking statements relating to the business, financial performance and earnings of SÜSS MicroTec SE and its subsidiaries and associates.

Forward-looking statements are based on current plans, estimates, projections and expectations and are therefore subject to risks and uncertainties, most of which are difficult to estimate and which in general are beyond the control of SÜSS MicroTec SE. Consequently, actual developments as well as actual earnings and performance may differ materially from those which explicitly or implicitly assumed in the forward-looking statements.

SÜSS MicroTec SE does not intend or accept any obligation to publish updates of these forward-looking statements.



SUSS MicroTec at a glance



- Hidden champion headquartered in Germany with 70+ year track record of innovation and growth
- Key technology provider for semiconductor frontend and advanced backend industry
- Global customer base with largest share of business in Asia
- Strategic partner for global semiconductor IDMs and foundries
- Innovator with relevant network to research institutes and universities
- 2025 Target: more than € 400 million revenue and >15% EBIT margin

299

in € million

Sales 2022

446

in € million

Order intake 2022

11%

EBIT margin 2022

SUSS is part of our digital life!



CFO

Dr. Cornelia Ballwiesser

- Finance and Controlling
- Legal and Compliance
- Internal Audit
- Investor Relations
- IT
- ESG



CEO

Burkhardt Frick

- Sales and Service
- Strategy
- HR
- Business Units:
Advanced Backend Solutions,
Photomask Solutions, MicroOptics



COO

Dr. Thomas Rohe

- R&D
- Purchasing
- Production
- Logistics
- Quality Management
- Product Center
- Facility Management

Our corporate vision defines our strategies

SUSS MicroTec Vision

**Leader in enabling innovative
advanced backend & photomask
solutions.**

Our world are the semiconductor frontend and backend process steps

Wafer fabrication



Front-end-of-line

Wafer process



- Deposition/coating
- Cleaning
- **Patterning/lithography**¹
- Etching
- Implantation
- Annealing
- **Permanent bonding**
- **Temporary bonding**
- CMP polishing

From middle-of-line to back-end-of-line

Advanced packaging

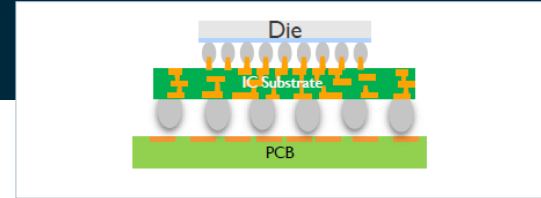

- Deposition/coating
- Cleaning
- **Patterning/lithography**
- Etching
- Annealing
- CMP polishing
- **Permanent bonding**
- **Temporary bonding**
- **Wafer-level packaging**
- Wafer dicing
- Panel-level packaging

Final packaging



- Mounting
- Wire bonding
- Molding encapsulation
- Trim & forming

¹ Only related to Photomask processing

Source: Yole, Lithography and Bonding Equipment for More than Moore 2022

Advanced Backend Solutions as core asset in our product portfolio

Frontend

Segments Photomask Equipment



Products

Photomask Equipment



MaskTrack X

Advanced backend

Advanced Backend Solutions¹

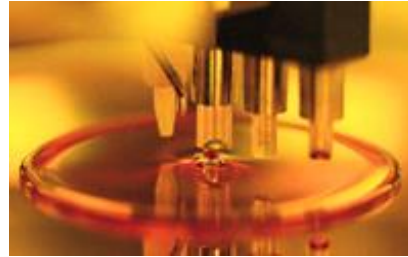
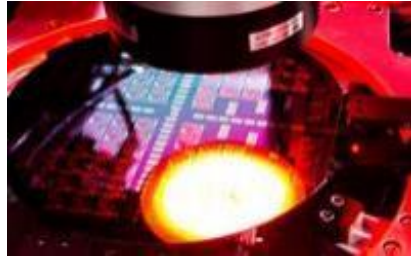

Imaging

Mask Aligner
MA200/300



Projection
Scanner
DSC300

Coating



ACS300

Bonding

XBC300



XB8

Components²

MicroOptics

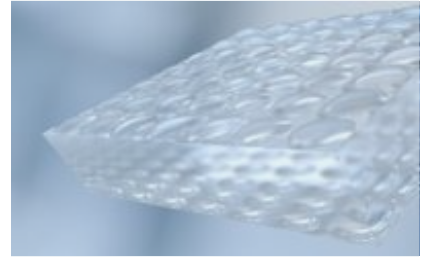

Microlens Arrays



Microlens Arrays

1) Business units Lithography and Bonder were merged into the new Advanced Backend Solutions business unit at the end of 2022. We will report in the new structure from the 2023 financial year onwards.
2) This business unit belongs no longer to the core business. We signed an agreement to sell the SUSS MicroOptics business to Focuslight Technologies on November 8, 2023.

Signing completed for the sale of MicroOptics business

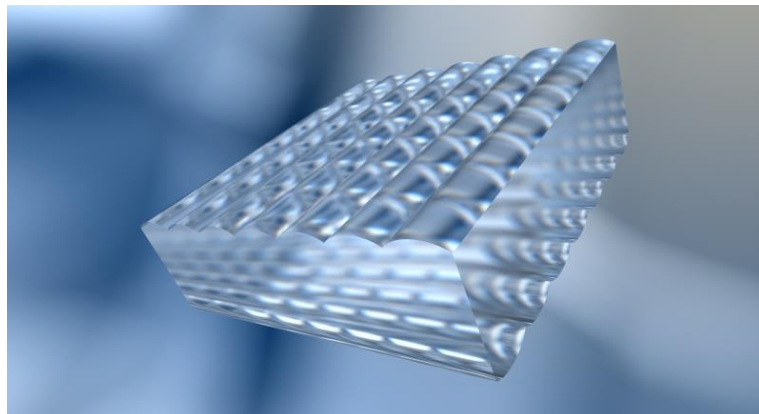

1

Reasons for divestment

- Limited synergies with core semiconductor equipment businesses (R&D, manufacturing, distribution)
- Further growth requires higher investment in automation and scaling
- We do not consider ourselves to be experts in targeted automotive business

2

Key facts of transaction

- Type: share deal (acquisition of 100% of SUSS MicroOptics SA shares)
- Transaction volume: € 75.5 million (includes acquisition of all shares and redemption of debt)
- Expected closing: Q1 2024
- Expected extraordinary income before taxes: € 40 to 45 million

3

Buyer's profile: Focuslight

- Listed at Shanghai stock exchange (ISIN: CNE100005XV2)
- ~ 800 employees
- Focus: diode laser components and laser optics
- Experienced in Western Europe through acquisition of German based company LIMO in 2017

AI related opportunity is larger than we initially expected

So far, we received AI related orders for our temporary bonders, debonders and cleaners worth ~ € **100** million.

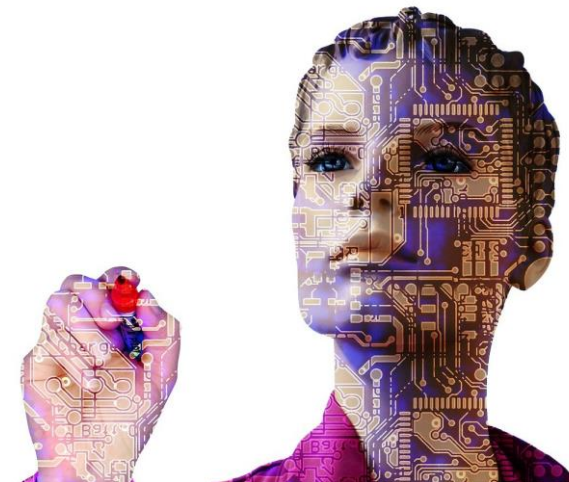

- + Demand for our solutions is boosted in particular by dramatic capacity increase at Korean and Taiwanese HBM (high bandwidth memory chip) manufacturers.
- + After a first order in June 2023, we received the largest POs in September and October.
- + As a result, we achieved the bonder's highest ever order intake in the third quarter of 2023.
- + To meet demand, we are qualifying our production site in Hsinchu (Taiwan) to build the XBS300 temporary bonding platform in the future. For this, we are hiring > 50 new employees.

We benefit from the boom in AI

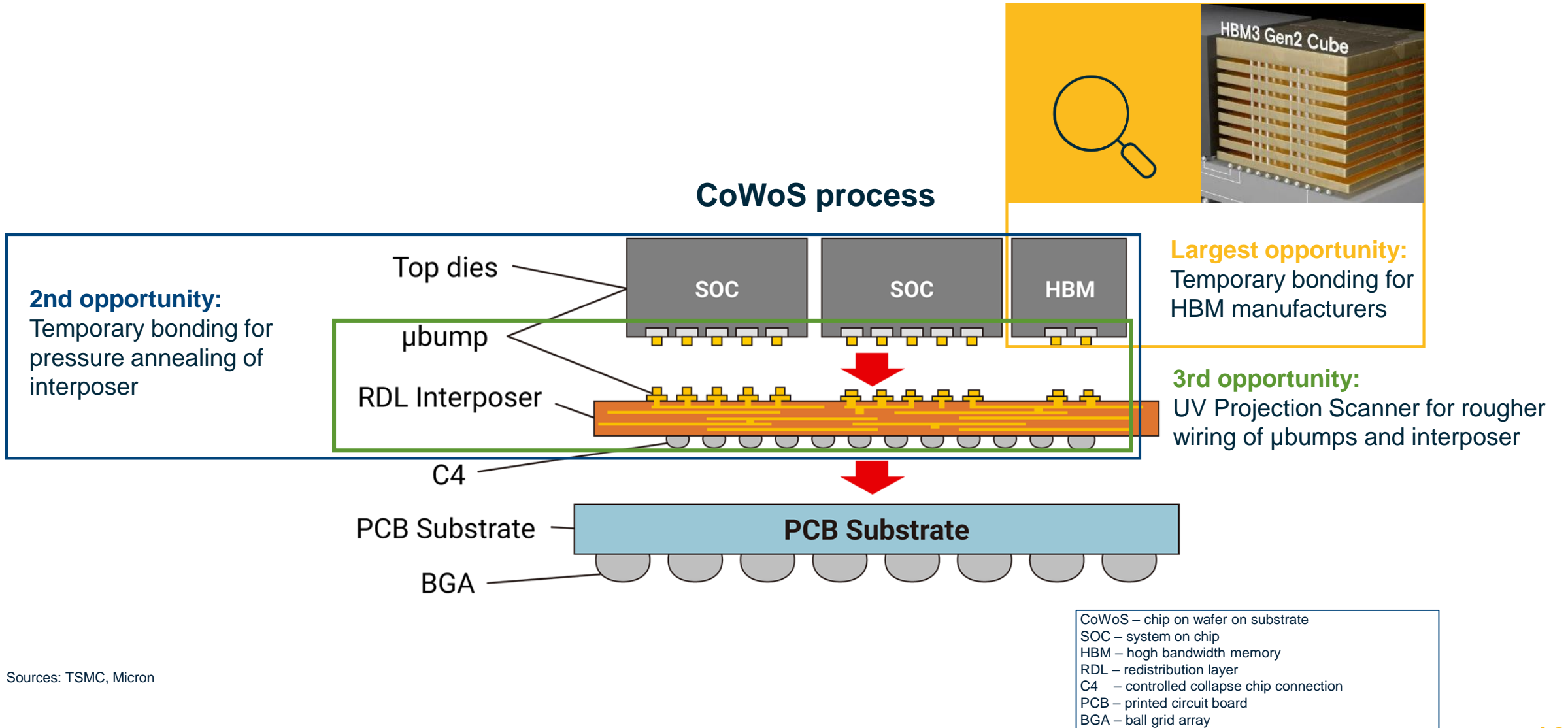

Sources: TSMC, Micron

Financial Results

Q3 2023*

281.2

in € million

Order Entry
9M 2023

202.3

in € million

Sales
9M 2023

33.5

in %

Gross profit margin
9M 2023

6.3

in %

EBIT Margin
9M 2023

**Guidance adjustment on October 25, 2023
for all three key financial indicators**

*excluding SUSS MicroOptics

Our adjusted guidance 2023



1) Without SUSS MicroOptics

2) Including one-off effects of € 3.1 million. Operating EBIT margin thus accounted to 9.9%.

Based on our business foundation we see further potential beyond

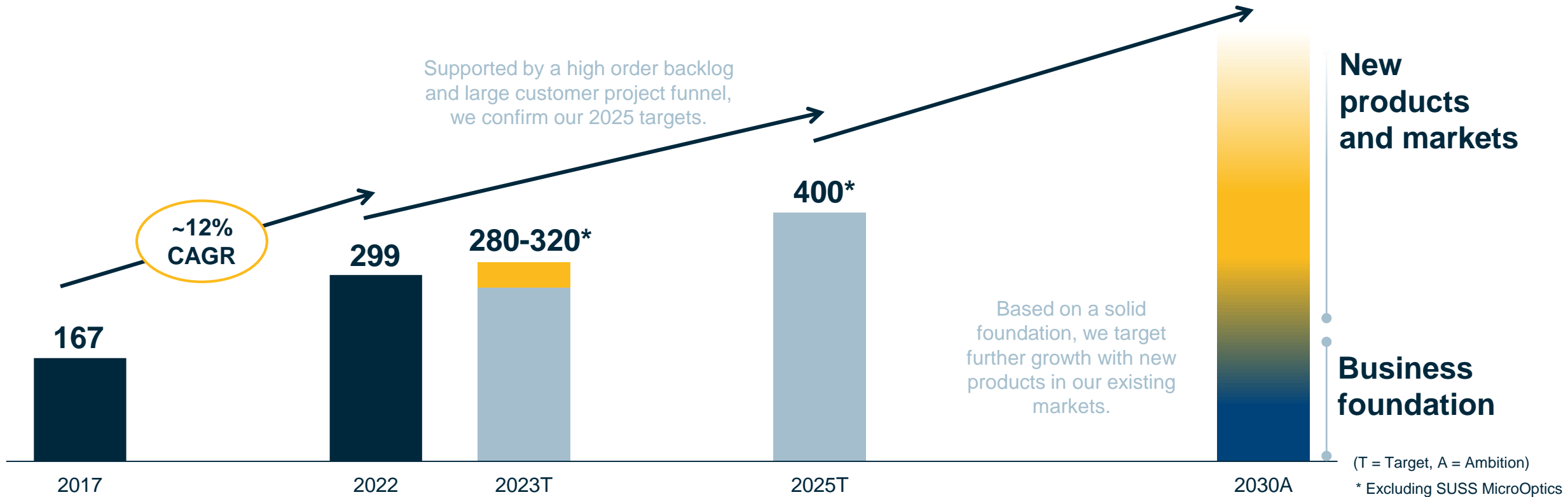

Major growth drivers 2023

- Converting high order backlog in Photomask Solutions and Bonder business into sales growth

Major growth drivers 2024/2025

- Bonding (especially with regard to AI-driven demand for temporary bonders)
- Photomask Solutions

Major growth drivers 2030

- General expected market growth in our core businesses (lithography, bonding, photomask)
- Hybrid Bonding
- Wafer Cleaning

Investor Relations Information

Contact



**Sven
Köpsel**

VP Investor Relations &
Corporate
Communications

Tel. +49 89 32007-151

E-mail sven.koepsel@suss.com



**Franka
Schielke**

Investor Relations
Manager

Tel. +49 89 32007-161

E-mail franka.schielke@suss.com

Financial Calendar 2024



March 27
Annual Report 2023



May 8
Q1 Report 2024



June 11
Annual General Meeting 2024



August 7
Half Year Report 2024



November 7
Nine Months Report 2024