

SUSS Investor Presentation

May 2026



Company Overview





SUSS at a glance



- Hidden champion headquartered in Germany with 75 years track record of innovation and growth
- Key technology provider for semiconductor frontend and advanced backend industry, benefiting from structural growth drivers such as Artificial Intelligence
- Global customer base with largest share of business in Asia
- Strategic partner for global semiconductor IDMs and foundries
- Innovator with relevant network to research institutes and universities

SUSS is part of our digital life!

Milestones in our company's history



1949

Company founded as Karl Süß KG in Munich

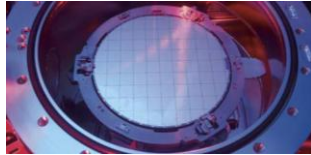

1990

Volume production of wafer bonder starts



2000

Coating systems added through acquisition of Fairchild Technologies



2010

Second German site established after acquisition of Hamatech APE

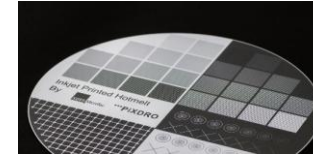

2020

Inkjet printing added to coating expertise through acquisition of PiXDRO



2024

Relaunch of the brand as SUSS



1963

World's first mask aligner SUSS MJB3 developed



1999

Initial Public Offering at the Frankfurt Stock Exchange completed



2001

Company renamed to SUSS MicroTec

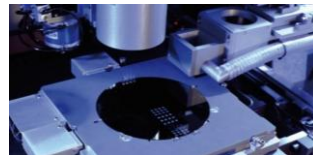

2012

Laser processing technology taken over from newly acquired Tamarack Scientific



2020

Asian production site opened in Hsinchu/Taiwan



2025

Opening of new and larger site in Zhubei/Taiwan

■ Company Milestones ■ Technology Milestones

Management Board of SUSS MicroTec SE



CFO
Dr. Cornelia Ballwiesser

- Finance & Controlling
- Legal & Compliance
- Risk Management
- Investor Relations
- IT
- ESG



CEO
Burkhardt Frick

- Sales and Service
- Strategy
- HR
- Internal Audit
- Business Units:
Advanced Backend Solutions,
Photomask Solutions



COO
Dr. Thomas Rohe

- R&D
- Purchasing
- Production
- Logistics
- Quality Management
- Product Center
- Facility Management

We are fully committed to driving the next chapter of innovation and growth in frontend (Moore's Law) and backend (More than Moore)

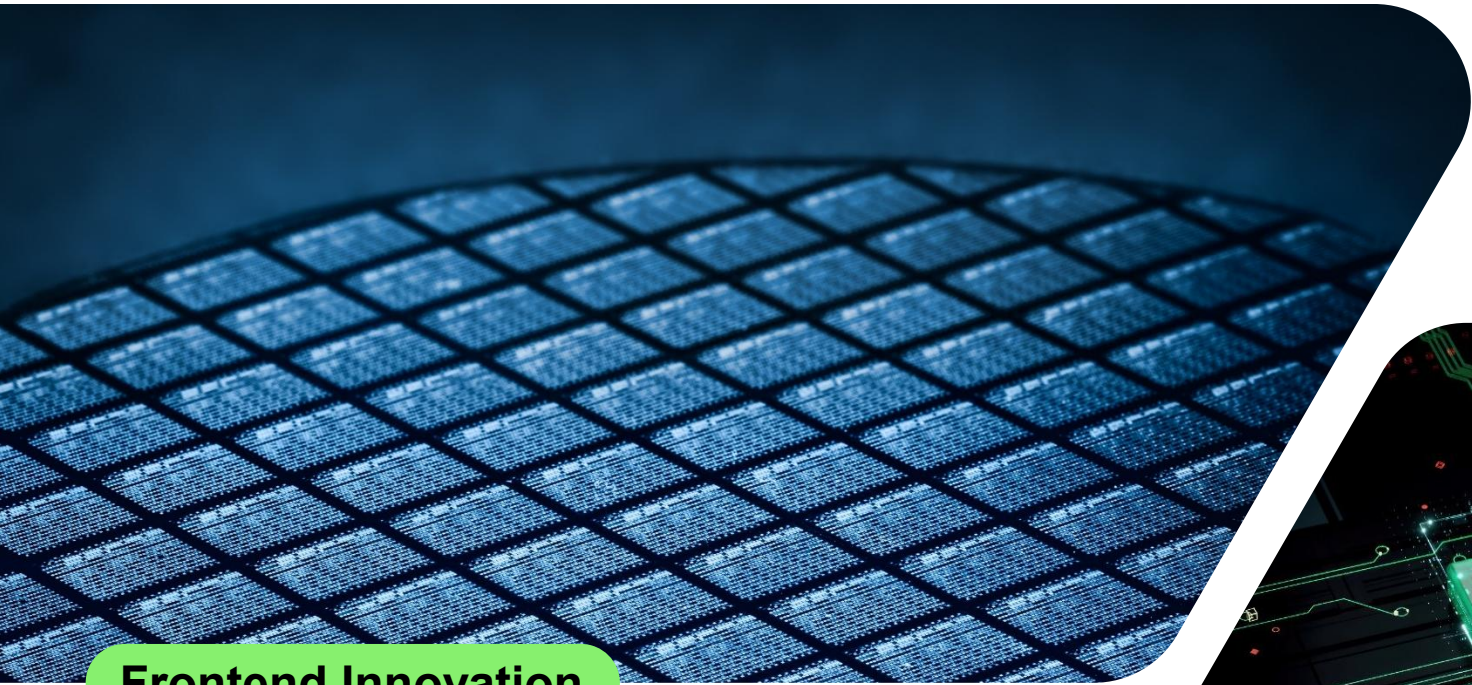

Frontend Innovation

Striving for the next technology node

Heterogeneous integration creates new multi-chip modules

Backend Innovation

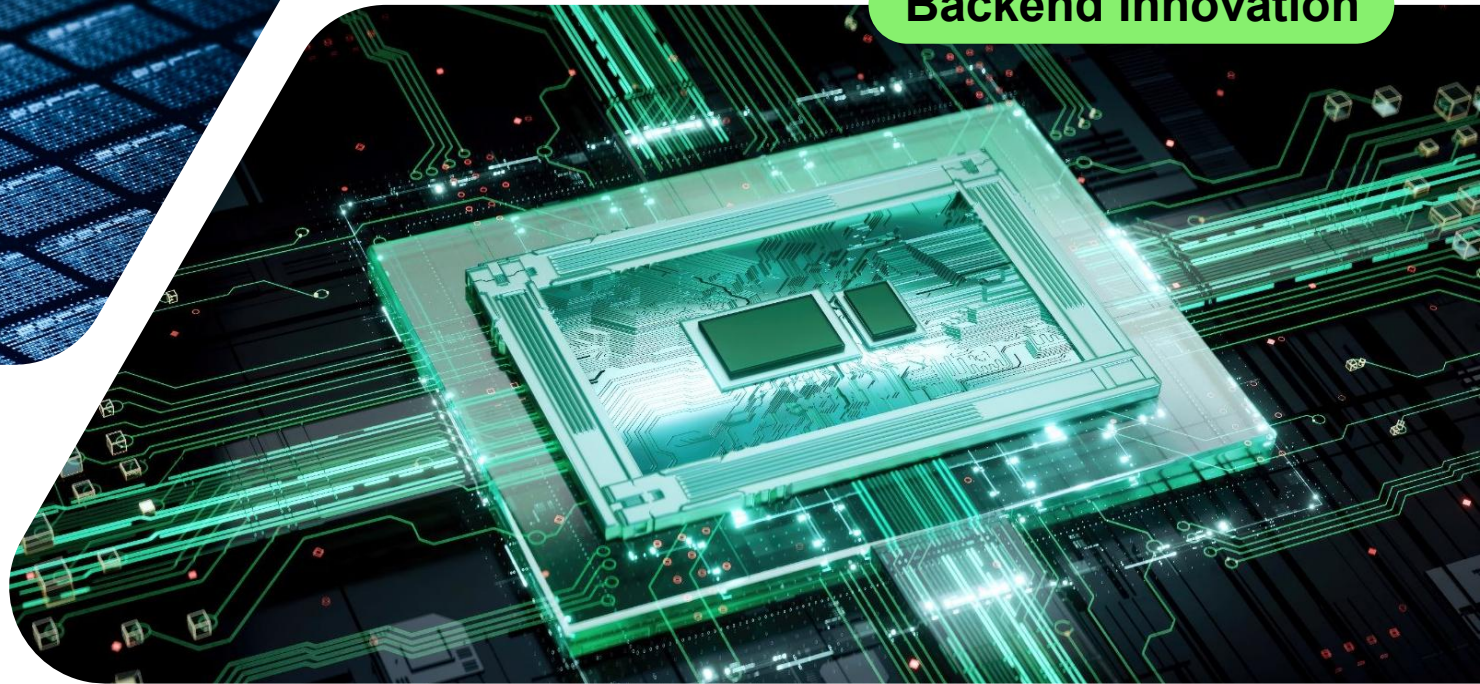

Our two segments, mainly serving the semiconductor industry

Frontend

Segments Photomask Solutions



Products Photomask Equipment



MaskTrack X

Advanced Backend

Advanced Backend Solutions



Imaging

Mask Aligner
MA200/300



UV Projection
Scanner
DSC300



Coating



ACS300

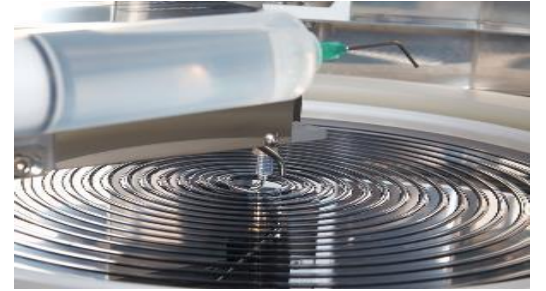

Bonding

XBC300



XBC300
Gen2 D2W

Photomask Solutions Portfolio Highlights



Clean
Strip
Develop

HMx Series



Clean
Strip Develop
PEB

Asx Series

SUSS portfolio includes photomask solutions from laboratory to high volume production. Our scalable solutions can support the next technology nodes.



Bake
Develop
AI Analysis

MaskTrack Smart BD



Pellicle Glue
Removal

MaskTrack X GB



Clean
Strip
Bake
Develop

MaskTrack PRO / X

Advanced Backend Solutions Portfolio Highlights – Imaging Systems



MASK
ALIGNER

MA/BA8 Gen4



PROJECTION
SCANNER

DSC300 Gen3

With over 60 years of innovation SUSS offers superior exposure solutions from laboratory to high volume production.



MASK
ALIGNER

MA200 Gen3



MASK
ALIGNER

MA300 Gen3

Advanced Backend Solutions Portfolio Highlights – Coating Systems



SUSS has the unique capability to offer tailored coating solutions for spin, spray and inkjet coating – depending on application needs.



Advanced Backend Solutions Portfolio Highlights – Bonding Systems



SUSS is market leader for temporary bonding and de-bonding solutions and complements the portfolio with permanent & hybrid bonding equipment.



SUSS hybrid bonding solutions – understanding customer’s needs



Wafer-to-wafer HB XBS300 W2W

Product launched: 10/2022
Target customers: HVM



Die-to-wafer/wafer-to-wafer HB XBC300 Gen2 D2W/W2W

Product launched: 05/2024
Target customers: Research institutes, R&D teams of HVM



Die-to-wafer HB XBC300 Gen2 D2W

Product launched: 5/2025
Target customers: HVM

We optimize our product solutions to serve our customer’s device and manufacturing needs.

HBM roadmap enables SUSS to grow in existing and new markets

in € million	HBM3E	HBM4	HBM4E	HBM5
Expected SOP	2024	2026	2026 or 2027	2027 or 2028
# of DRAM layer acc. to JEDEC	8/12	12	16	16/20
Bonding type in DRAM stack	TCB	TCB	TCB and HB	TCB and HB
Thinning of DRAM devices	TBDB	TBDB	TBDB	TBDB

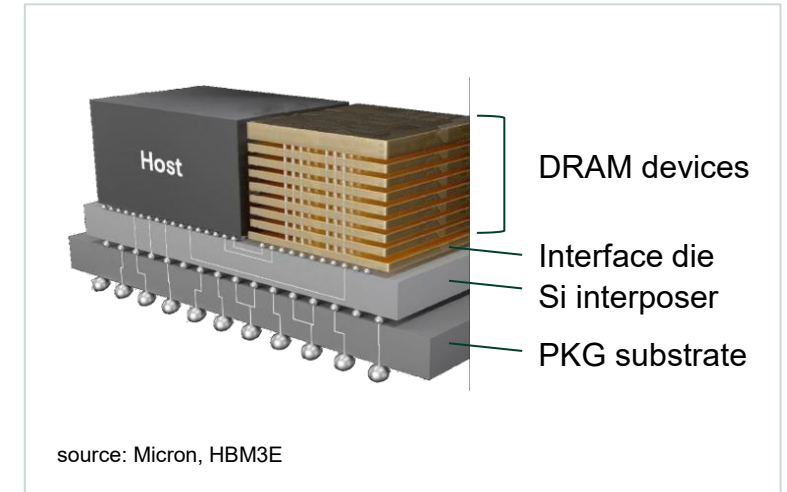

Relevance for SUSS:

1

TBDB remains a crucial process for thinning of DRAM devices used in HBM cube

Growth of existing SUSS TBDB business in line with general HBM market growth

2

Increase of layer number in HBM cube triggers more TBDB capacity for thinning of DRAM devices

Additional growth of SUSS TBDB business in line with higher layer in HBM cube

3

Hybrid bonding will gradually replace Thermal Compression bonding for stacking of DRAM devices

Expansion into this market offers new growth opportunities with SUSS HB solutions

TCB: Thermal compression bonding, HB: hybrid bonding, TBDB: Temporary bonding & de-bonding

2.5/3D Chiplet Technology | SUSS well positioned to benefit from the strong momentum in 2.5D and 3D evolution

Temporary Bonding	<ul style="list-style-type: none"> • HBM: Structural support during thinning
Hybrid Bonding	<ul style="list-style-type: none"> • HBM: Stacking of DRAMs¹ • CPO: Stacking of PIC & EIC¹ • SoIC: E.g., Logic-on-Logic¹
Inkjet-/Spin Coating	<ul style="list-style-type: none"> • TIV: Lithography • RDL: Lithography¹
UV-Scanner (Exposure)	<ul style="list-style-type: none"> • TIV: Lithography • RDL: Lithography¹
Photomask Cleaning (Frontend)	<ul style="list-style-type: none"> • HBM: Mask Cleaning in DRAM manufacturing • SoIC: Mask Cleaning in Logic manufacturing
Wafer Cleaning	<ul style="list-style-type: none"> • HBM: Critical material removal and final cleaning in Backend manufacturing¹

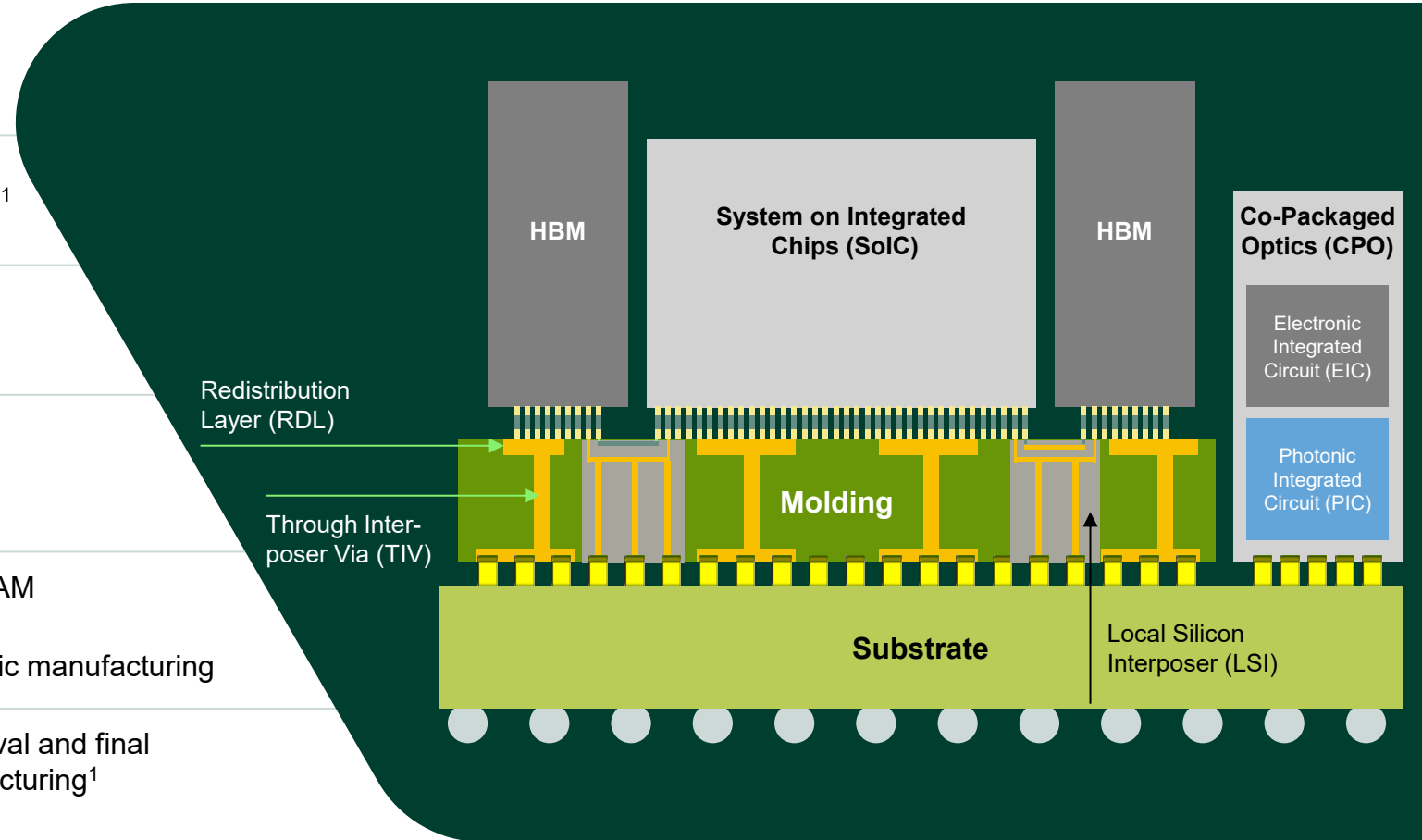

¹ Potential future use case ● BU Advanced Backend Solutions ● BU Photomask Solutions

Our three manufacturing sites for semiconductor equipment

	Garching HQ, Germany	Sternenfels Germany	Hsinchu/Zhubei Taiwan
Photomask Cleaning		MaskTrack X	
Bonding Systems		XBC300	XBS300
Coating Systems			ACS300
Imaging Systems	Mask Aligner MA200/300		UV Projection Scanner DSC300
Operations employees 2025	48	176	175

New production site in Zhubei officially opened

New production site in Zhubei has officially opened on October 30, with more than > 100 guests including high-level customers.



Zhubei project progress

- Technical installations and interior outfitting completed; all necessary licenses have been obtained
- Construction of the first tools at the new location has begun; first deliveries of tools produced in Zhubei in early 2026
- Leasing contracts for old locations terminated by the end of Q1 2026 at the latest

Financials Q1 2026



Order intake at a record high – Q1 expected to be the low point in sales over the course of the year

Financial Results

Q1 2026

149.3

in € million

Order intake
Q1 2026

+69.5% YoY

86.5

in € million

Sales
Q1 2026

-30.7% YoY

36.1

in %

Gross profit margin
Q1 2026

-3.1pp YoY

4.3

in %

EBIT margin
Q1 2026

-13.7pp YoY

Segment Overview Q1 2026

Advanced Backend Solutions

in € million	Q1 2026	Q1 2025
Order intake	99.7	54.3
Order book as of March 31	229.8	241.5
Sales	55.7	83.8
Gross profit	17.8	31.7
Gross profit margin	32.0%	37.8%
EBIT	-3.0	10.7
EBIT margin	-5.4%	12.7%

- Order intake significantly above Q1 2025, orders were strongest for Bonding Systems. Demand for Imaging Systems remained strong after a strong Q4 2025, particularly due to CoWoS-related orders for our UV projection scanner. Order intake for coaters below Q4 levels.
- Segment sales down one third compared to Q1 2025, Imaging Systems the only product line with strong growth, Bonding Systems significantly lower. Sales divided evenly between the three product lines.
- Profitability clearly below 2025 level, mainly due lower cost coverage.

Photomask Solutions

in € million	Q1 2026	Q1 2025
Order intake	49.6	33.7
Order book as of March 31	100.4	149.5
Sales	30.8	41.2
Gross profit	13.3	17.1
Gross profit margin	43.2%	41.5%
EBIT	7.1	14.4
EBIT margin	23.1 %	34.9%

- Orders increased strongly, customers from China sourcing cleaning equipment more actively and contributed 1/3 of the order intake in the Segment.
- Sales declined in Q1 – also due to the weak order intake in 2025.
- The customer mix with a high sales share from Chinese customers supported the strong gross profit margin development.
- EBIT-Margin declined mostly because of lower cost coverage and customer mix.

Order intake momentum remains positive; EBIT margin under pressure due to lower cost absorption

Sales of €86.5 million reflect weaker order entry in summer 2025.

Order intake
€149.3m (Q1 2026)

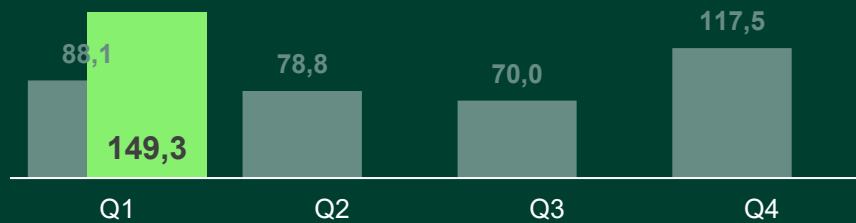

Sales
€86.5m (Q1 2026)

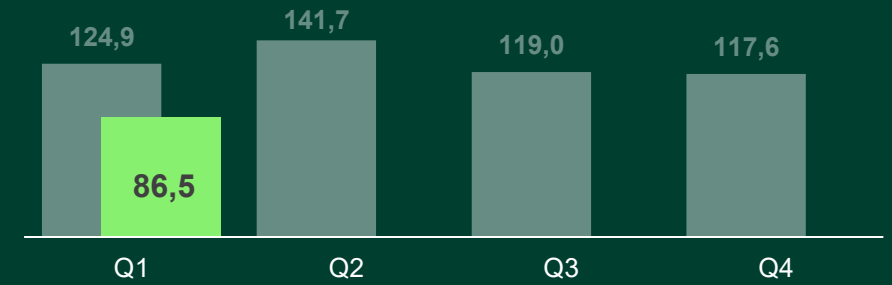

Gross profit margin
36.1% (Q1 2026)

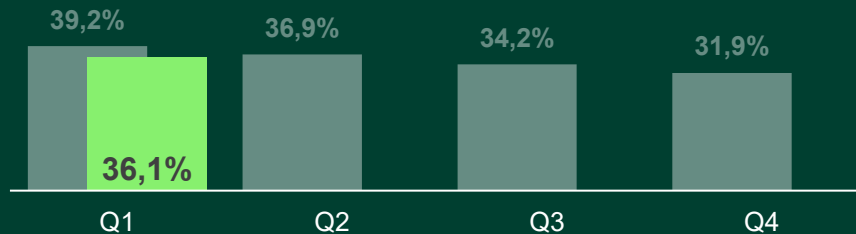

EBIT margin
4.3% (Q1 2026)

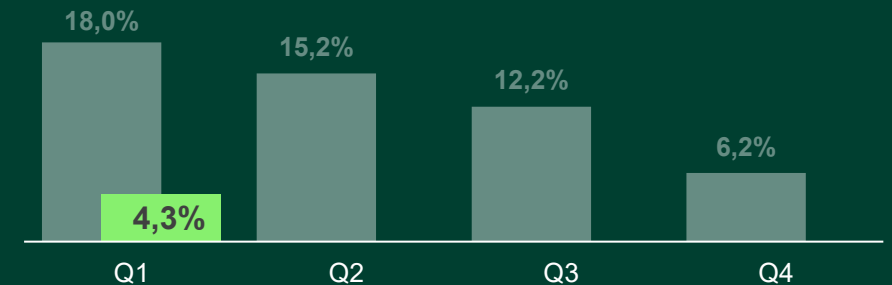

■ 2025 ■ 2026

The prior-year figures have been adjusted.

Significantly stronger order intake in both segments in the first quarter

Order intake
(Q1 2026)

€149.3m

Sales
(Q1 2026)

€86.5m

Gross profit margin
(Q1 2026)

36.1%

EBIT margin
(Q1 2026)

4.3%

Order intake by quarters

Sales by quarters

Gross profit margin by quarters

EBIT margin by quarters

Advanced Backend Solutions

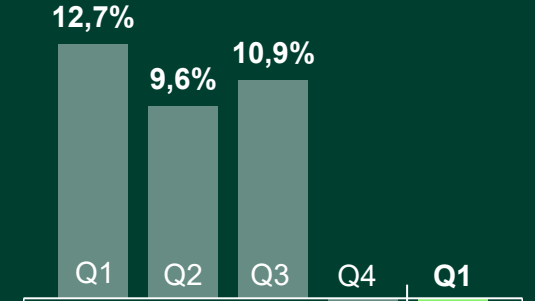
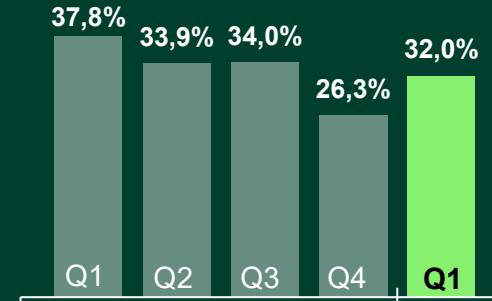
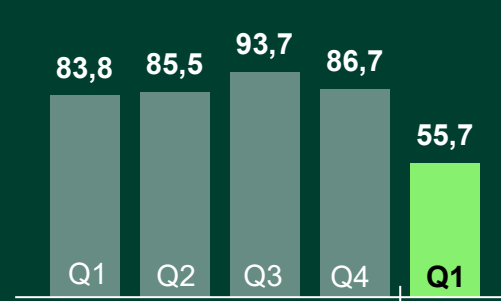
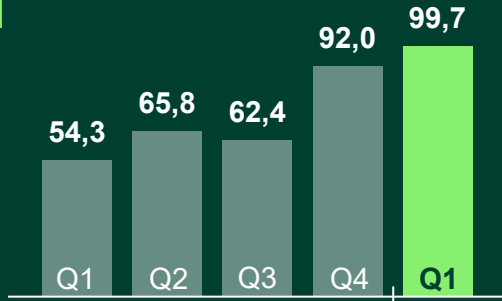

Photomask Solutions

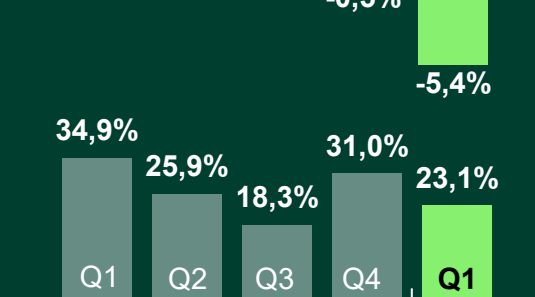
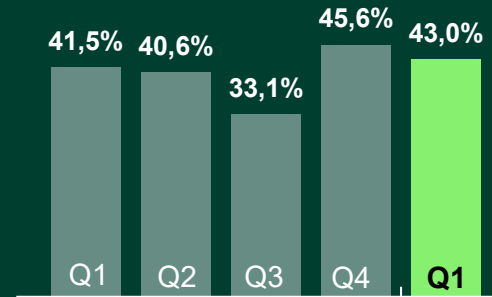
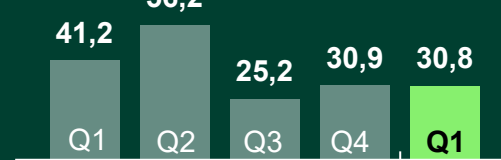
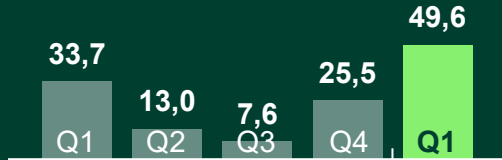

The prior-year figures have been adjusted.

Transition year 2026: A temporary dip in sales is expected, leading to lower fixed-cost coverage and, together with rising R&D expenses, to a lower EBIT margin while the gross profit margin remains broadly stable

Guidance 2026

(as of March 30, 2026)



Market outlook and Ambition 2030



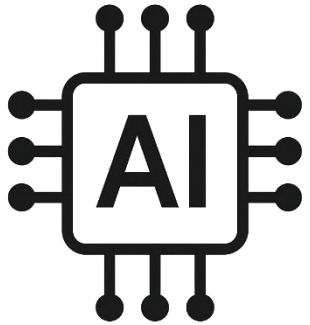

Today's tech trends, accelerated by AI, are built on semiconductors
Fueling rapid growth across the semiconductor ecosystem

Trend Selection – not exhaustive

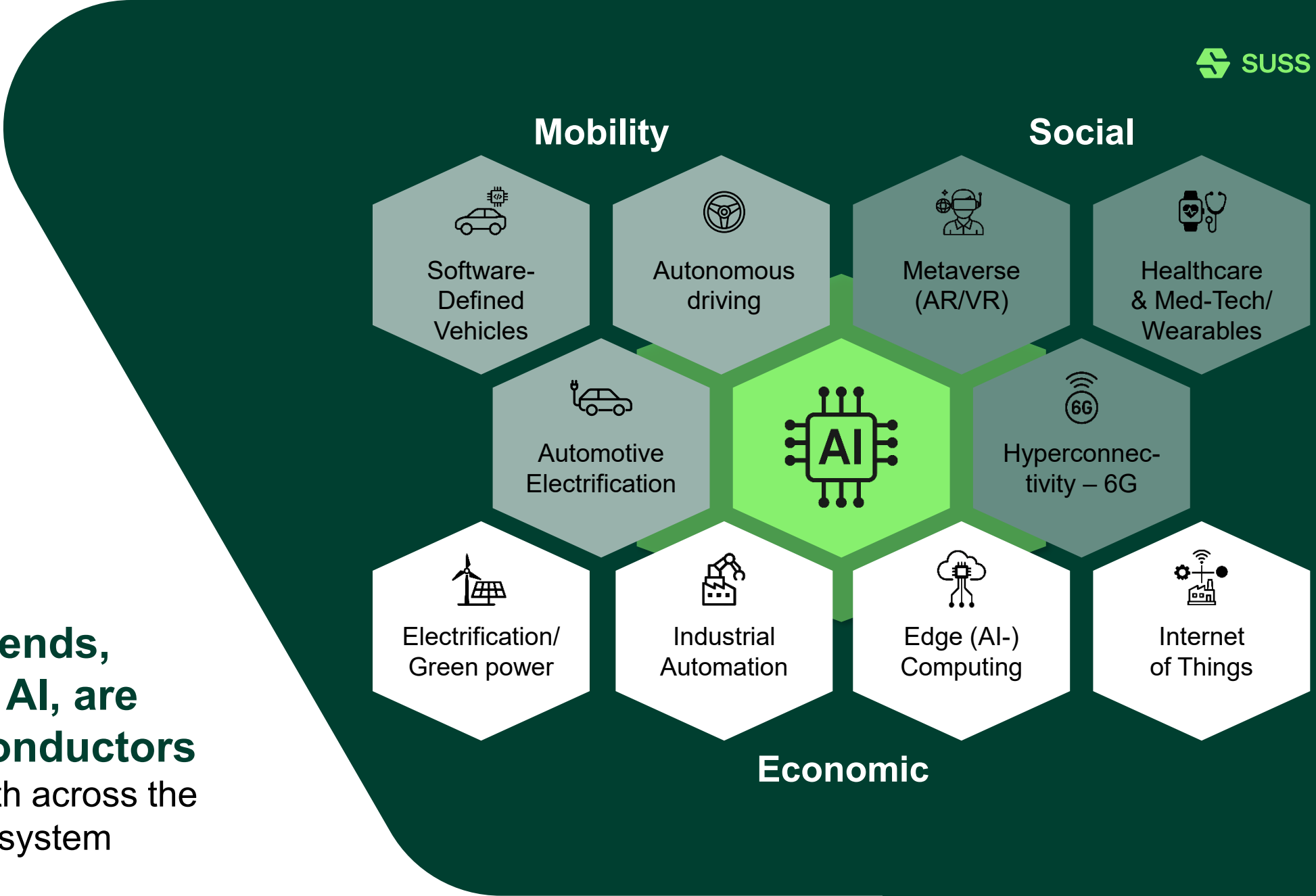

AI-led secular trends are driving semiconductors toward a \$1 trillion market by 2030

Semiconductor device revenue forecast (€bn) & key growth driver

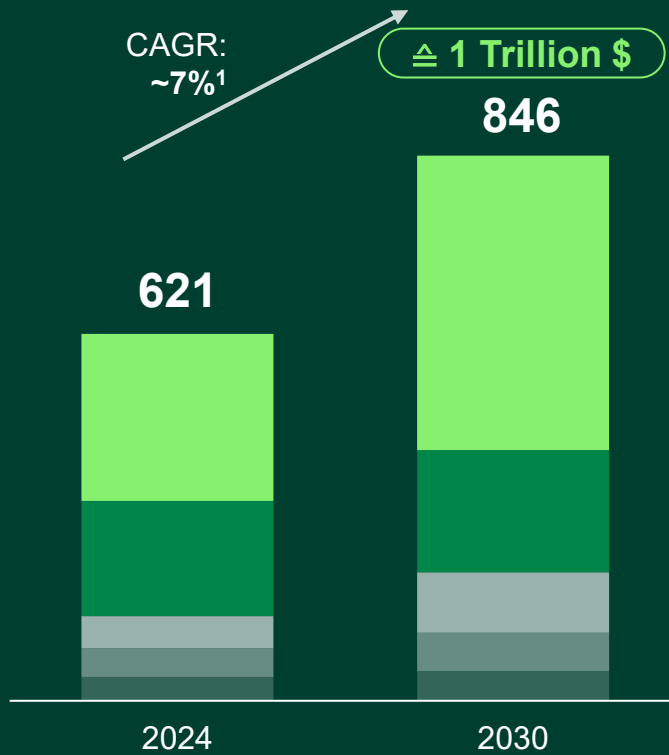

Market segment	Growth-drivers
Computing & Data Storage	AI (Generative-, Agentic-, Physical-AI) Key growth driver
	Autonomous driving
	Industrial Automation / Internet of Things
	Metaverse (AR/VR)
Communications	Hyperconnectivity – 6G
Automotive	Software-Defined Vehicles / Autonom. driving
	Automotive Electrification
Industrial	Industrial Automation / Internet of Things
	Electrification / Green power generation
Consumer	Metaverse (AR/VR)
	Healthcare Wearables

¹ Based on USD values

Source: SUSS Research; market size based on Yole (2025); Note: USD/EUR forward exchange rate = 1.18, USD/EUR 2024 exchange rate = 1.08, Trend Selection – not exhaustive

Rising application requirements are blurring the lines between Frontend & Backend territories – addressed in our Business Unit strategy

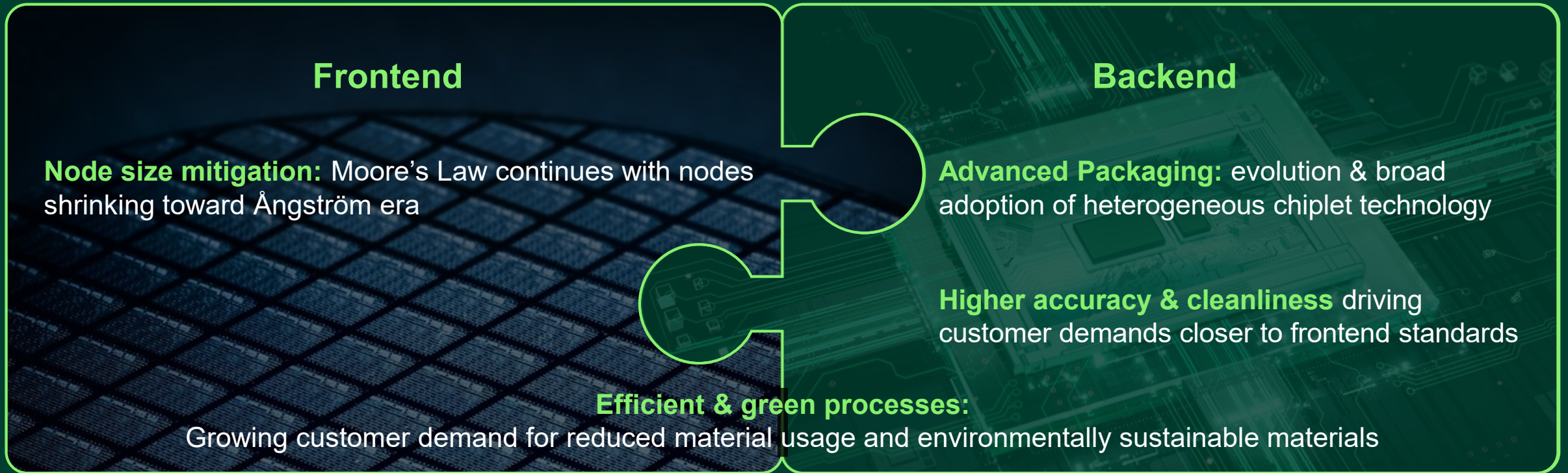

Photomask Solutions

Photomask Cleaning, Bake & Develop

Wafer Cleaning

Advanced Backend Solutions

Bonding, Coating & Imaging

Advanced Packaging | Strong growth ahead – largely fueled by 2.5D and 3D packaging

As demand for high-performance computing rises, the **value in Advanced Packaging is shifting** toward high-end technologies

Advanced Packaging forecast [Million Wafer/Year]

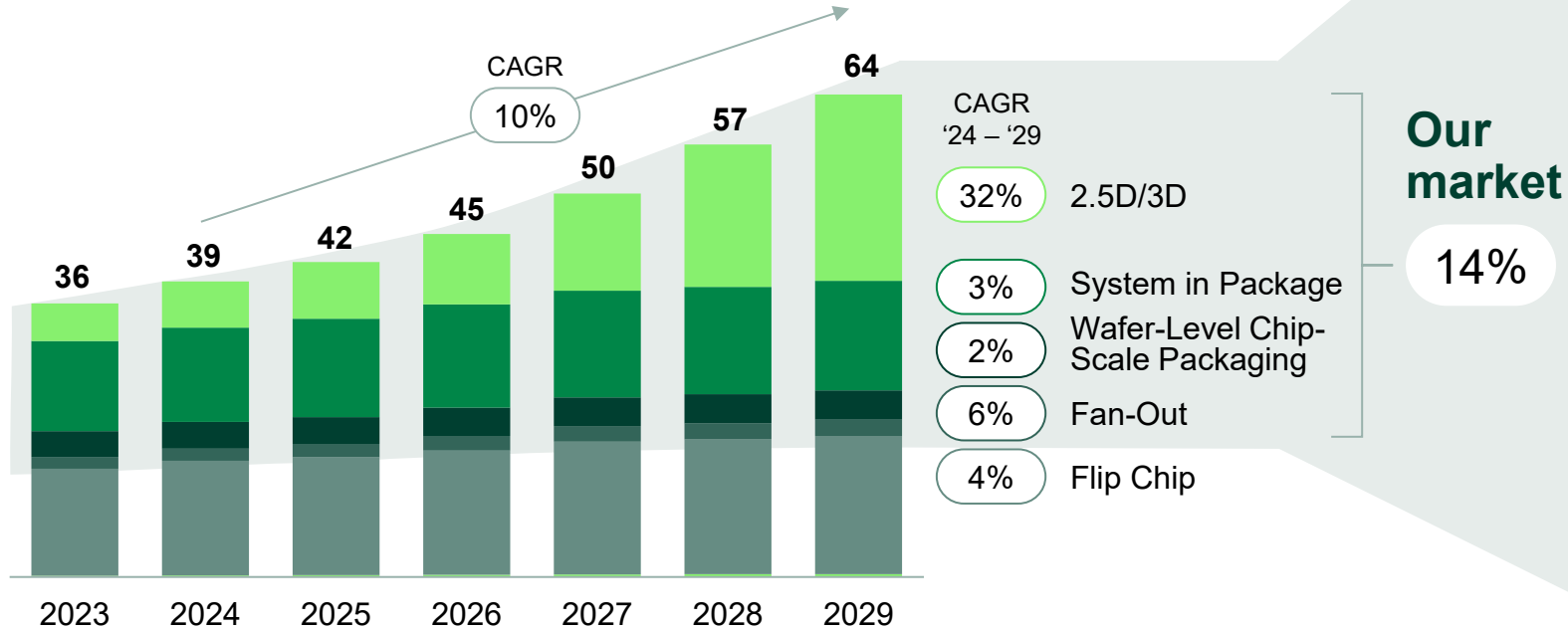

XX% CAGR '24 – '29
Source: Yole (2024)

Interconnection of chips, wafers, and interposers (e.g., Redistribution Layers, Through-Interposer Via, Micro Bumps)

- > Patterning with our Lithography equipment: (Coater & Developer, Exposure equipment)

Structural support for thin elements

- > Temporary bonding on carrier wafer with our temporary bonding/de-bonding equipment

Mounting dies onto other dies or interposers

- > Interposer stacking and die attach/stacking with our permanent bonding equipment (incl. Hybrid Bonding)

Our market

14%

Serviceable market is expected to grow by ~7% per annum through 2030

Serviceable Available Market (Revenue in €M)

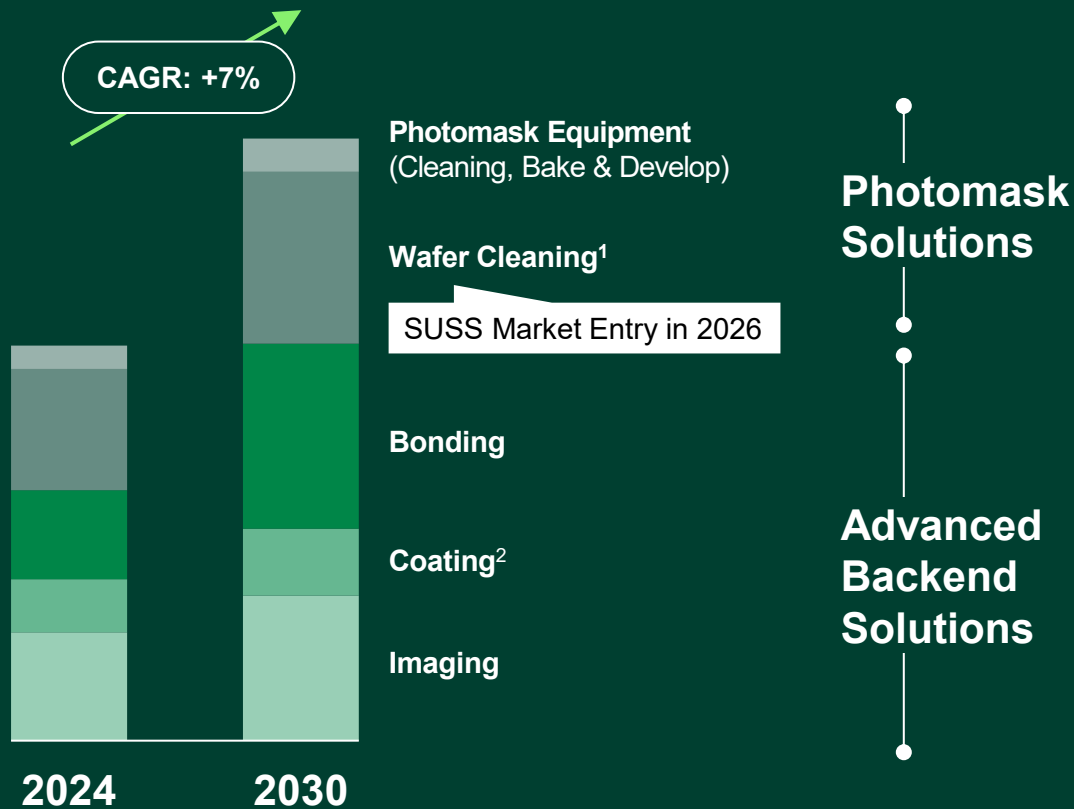

¹ MEMS, Power, CIS & Advanced Packaging market reflected; ² Only Backend Coating market; Inkjet: Upside from expanding into additive manufacturing not reflected | Source: SUSS Research, primarily based on Yole



Photomask Equipment

- **High-End mask market leading growth**
- Mid-End mask market growing mid-to high single digits annually



Wafer Cleaning

- **Market entry with MEMS, Power & CMOS Image Sensors**; Expansion into Advanced Packaging with 300 mm tool planned (tool launch in 2027)
- Memory – future upside (not in market size reflected)



Bonding

- **Temporary Bonding will continue to grow** especially driven by high demand for AI
- **Hybrid Bonding with strong growth** ahead driven by advanced Logic & Memory



Coating

- **Advanced Packaging drives growth** in Backend Coating segment
- **Inkjet offers upside beyond traditional coating**, expanding into additive manufacturing



Imaging

- **Advanced Packaging fuels growth**; larger reticle-size dies supports adoption of full-field projection scanning

SUSS long term ambitions for 2030

€ 750 – 900 m

Sales
SUSS Ambition 2030

~ 9 – 13% annual sales growth
compared to 2025e

43 – 45%

Gross profit margin
SUSS Ambition 2030

+ ~8%-points GP margin
expansion compared to 2025e

20 – 22%

EBIT margin
SUSS Ambition 2030

+ ~9%-points EBIT margin
expansion compared to 2025e

SUSS long term ambitions for 2030

€ 750 – 900 m

Sales
SUSS Ambition 2030

~ 8 – 12% annual sales growth
compared to 2025

43 – 45%

Gross profit margin
SUSS Ambition 2030

+ ~8%-points GP margin
expansion compared to 2025

20 – 22%

EBIT margin
SUSS Ambition 2030

+ ~8%-points EBIT margin
expansion compared to 2025

Upcoming new product introductions – initiating next growth phase



Photomask Solutions

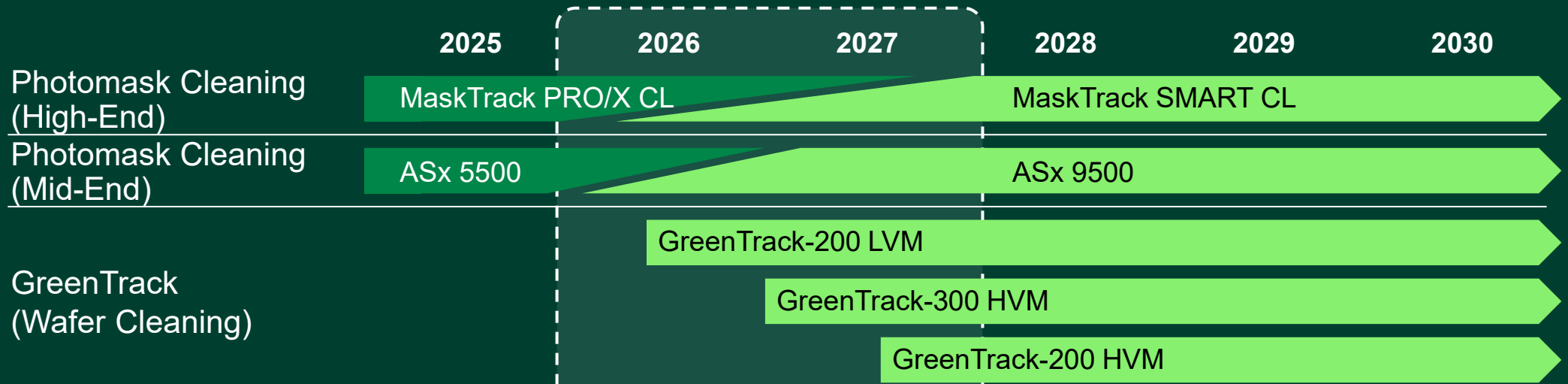

Advanced Backend Solutions

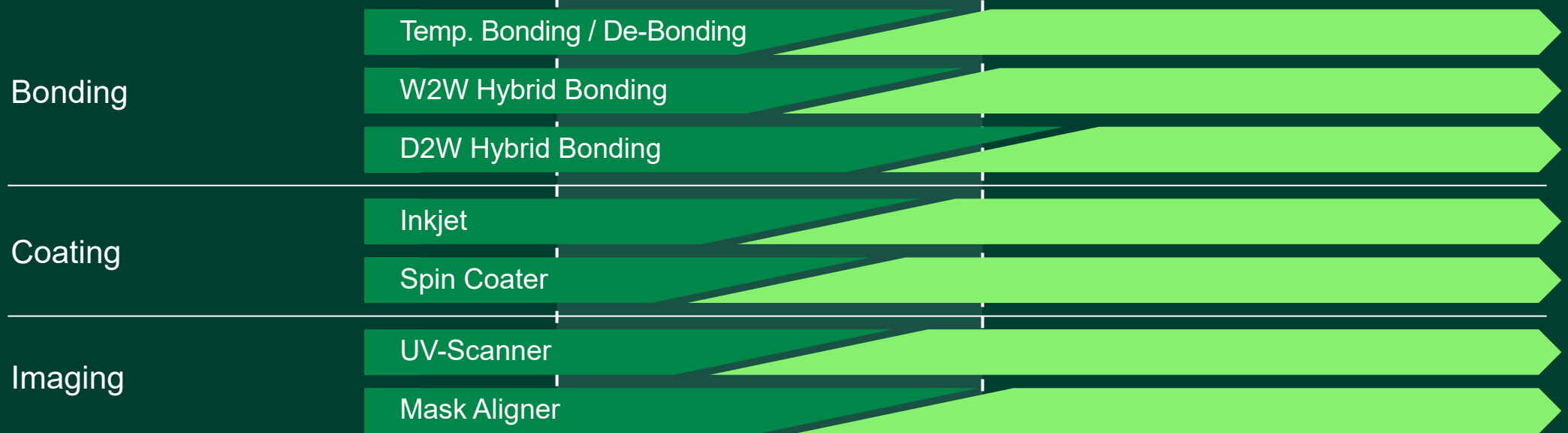

More diversified regional growth – with normalizing China share

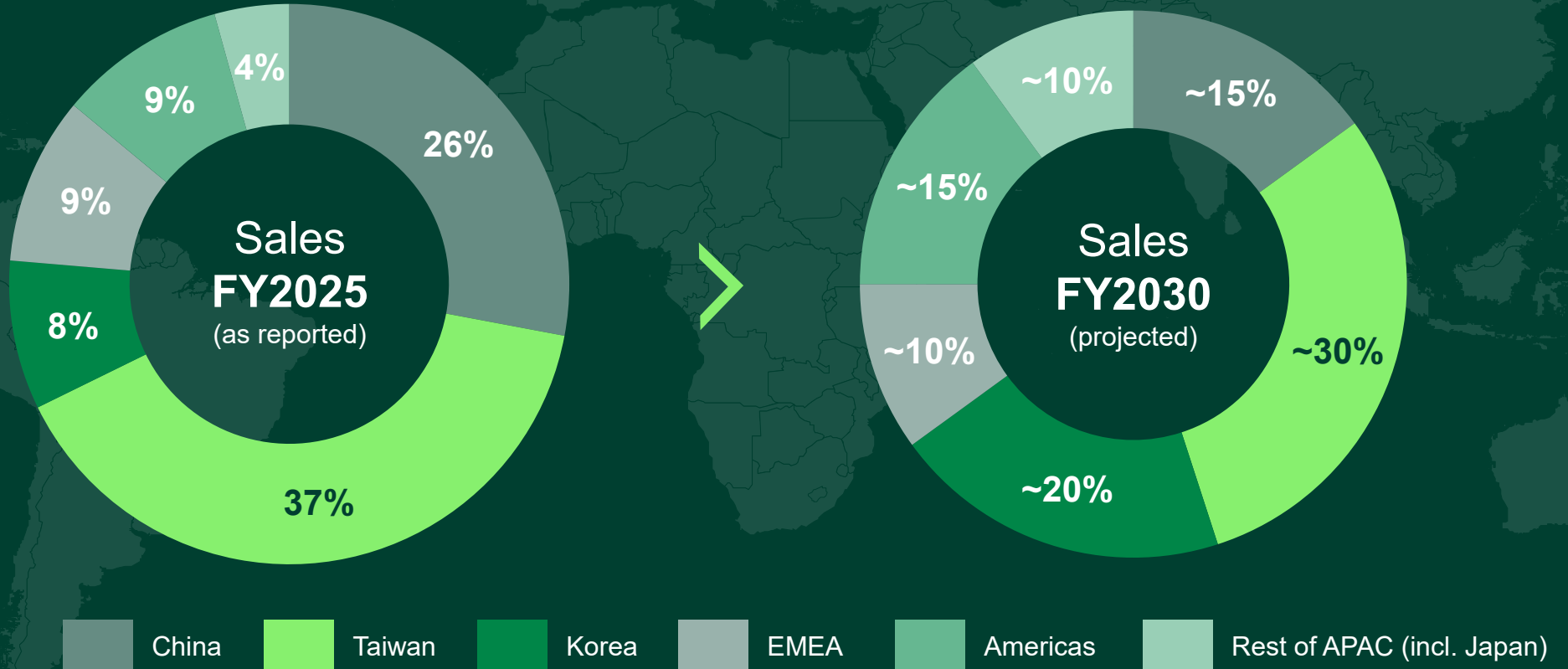

SUSS – a valued partner in the semi ecosystem – Working alongside leading chip companies, as well as key research and industrial partners

We have expanded our global standing and have become a valued part of the semi ecosystem.

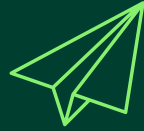

Our key success factors are:

- Focusing on market leaders
- Engaging into commercial and technology partnerships
- Creating customer intimacy through joint process development and key account management
- Local presence with highly qualified customer service and application support

Foundries and OSATs



Integrated Device Manufacturers (IDMs)



Technology and material partners



Academia, consortia and institutes



¹ 3DIC Advanced Manufacturing Alliance

Group growth based on strong evolving portfolio, new product introductions, and a strengthened service business

Revenue development (in €M)

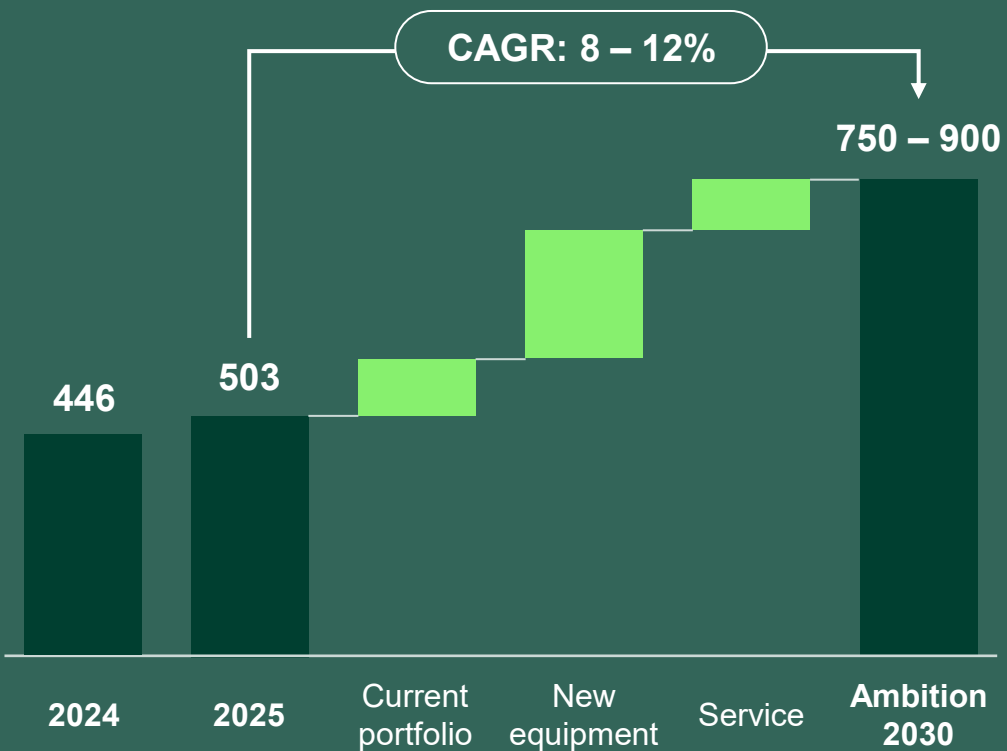

Current portfolio – key revenue drivers:

- Photomask Equipment** Remain #1 in high-end segment and expand leadership into mid-end segment
- Temporary Bonding** Sustaining leadership – especially in the HBM market segment
- UV-Scanner** Expand footprint in Advanced Packaging, leveraging strong position at the #1 foundry

New equipment – key revenue drivers :

- Wafer Cleaning** Enter the Wafer cleaning market with an innovative, cost-efficient & green solution
- Hybrid Bonding** Entry into Advanced Logic and HBM market, enabled by excellent technological performance
- Inkjet Coating** Shaping Inkjet market – a cost-efficient Coating solution and enabler for Additive Manufacturing

Service – key revenue drivers:

Growing Service revenue share from 18% to 25%, with Service now a strategic business contributor

Growth path underpinned by AI-driven market tailwind and continued expansion into new segments

SUSS
2025 - 2030
8 – 12% sales growth p.a.

=

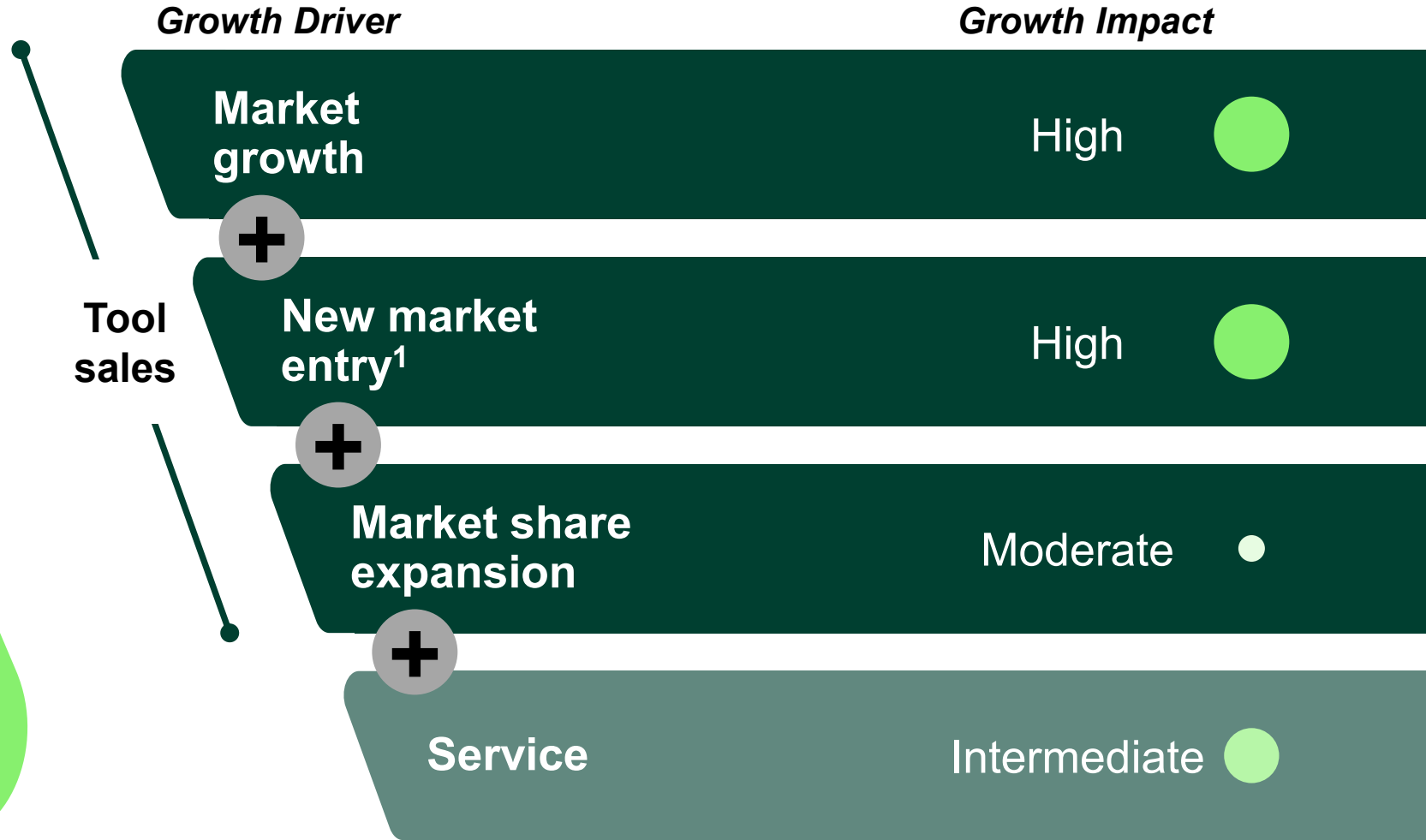

1) Wafer Cleaning & Hybrid Bonding

Active pursuit of inorganic growth – we have the means and are looking for the right fit

Revenue development (in €M)

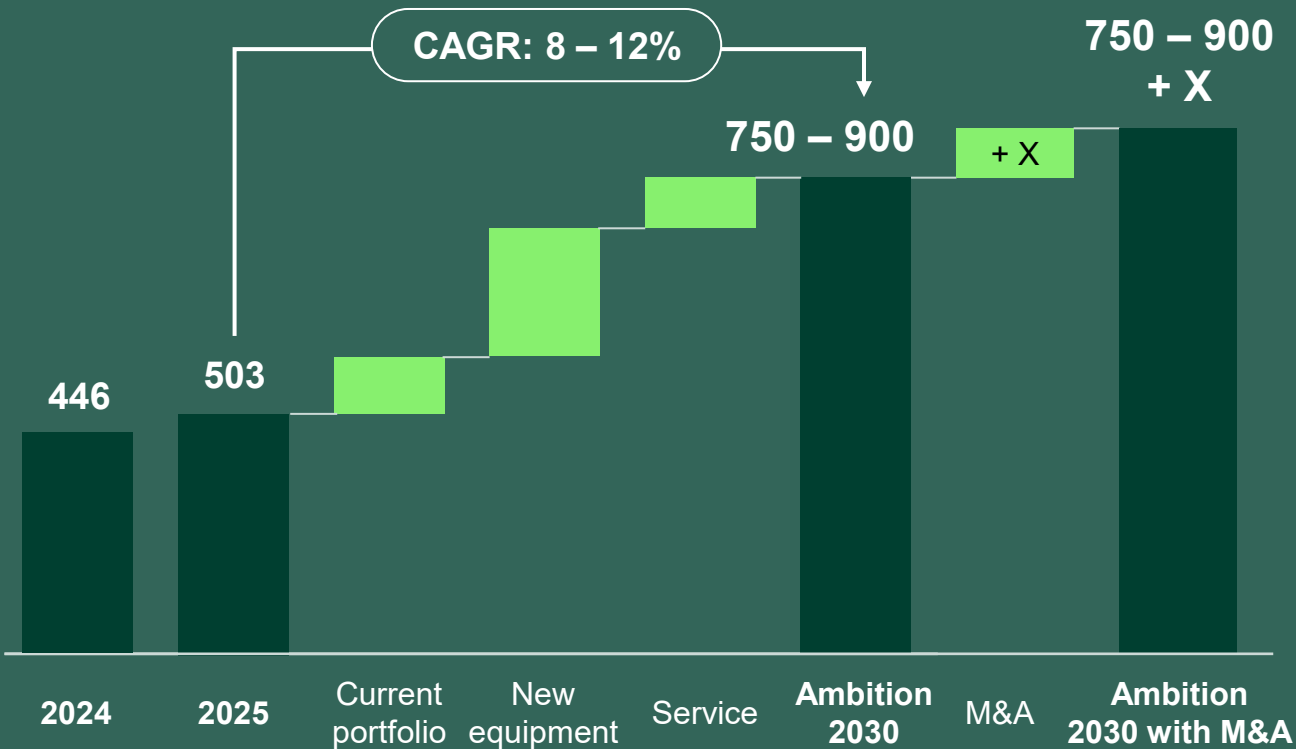

Strategically enhancement of existing portfolio



- Acquisition must support existing strategic priorities, not merely broaden the portfolio
- Acquisition should not structurally dilute our margin
- Carve out and integration efforts need to be manageable – culturally, operationally, and organizationally

Acquisition of Know-How to accelerate product development



- In-house development not feasible, or significant time savings achievable through acquisition
- Clear path to monetization must be visible

Balanced margin expansion driven by the existing portfolio, new equipment platforms, and service

Gross profit margin development (in %)

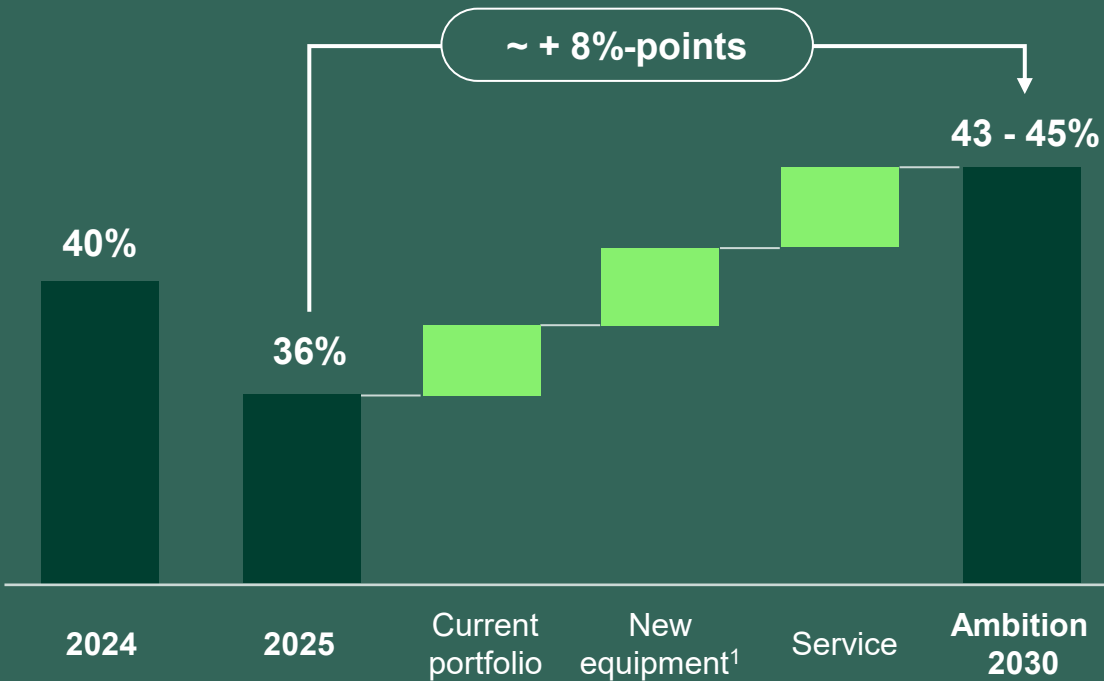

1) Wafer Cleaning, Hybrid Bonding & Inkjet

Current (evolving) portfolio:

- New modular & standardized product generations (e.g. new Mask Cleaner, UV-Scanner & Mask Aligner)
- Optimized production network & further improved capacity utilization

New equipment:

New products with higher margins than the current portfolio due to new equipment design (exception: Hybrid Bonder, where the die-bonding module is sourced externally)

Service:

Overall margin improvement through more strategic installed base management and focused service product portfolio

EBIT margin to benefit from higher business volume while increased R&D spend is covered by decline of SG&A expense ratio

How to achieve the targeted EBIT margin of 20 – 22%

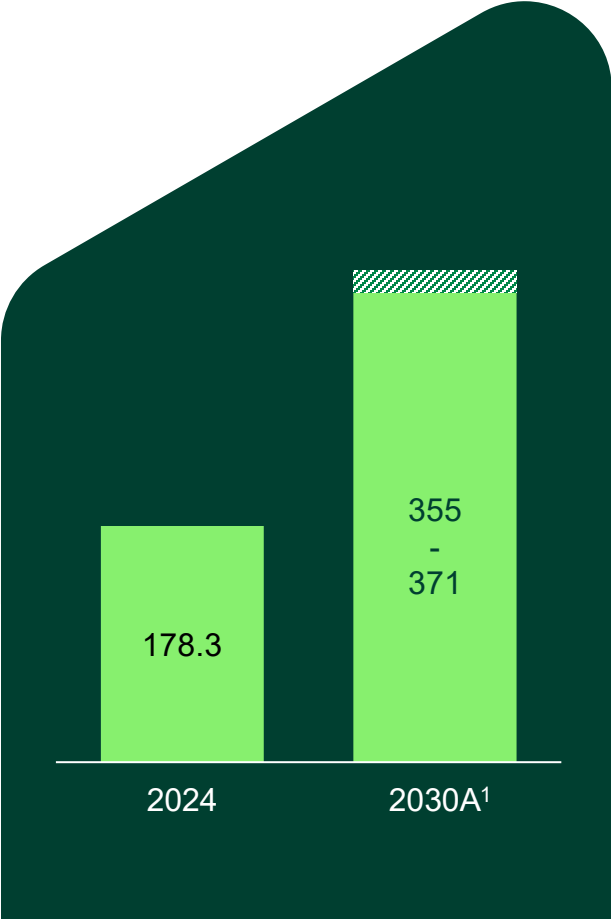

Benefiting from increase in gross profit

Gross profit has the potential to ~ **double** from 2024 to 2030, driven by larger business volume with improved profitability

¹ Gross profit is calculated based on the mid-point of the 2030 sales ambition.

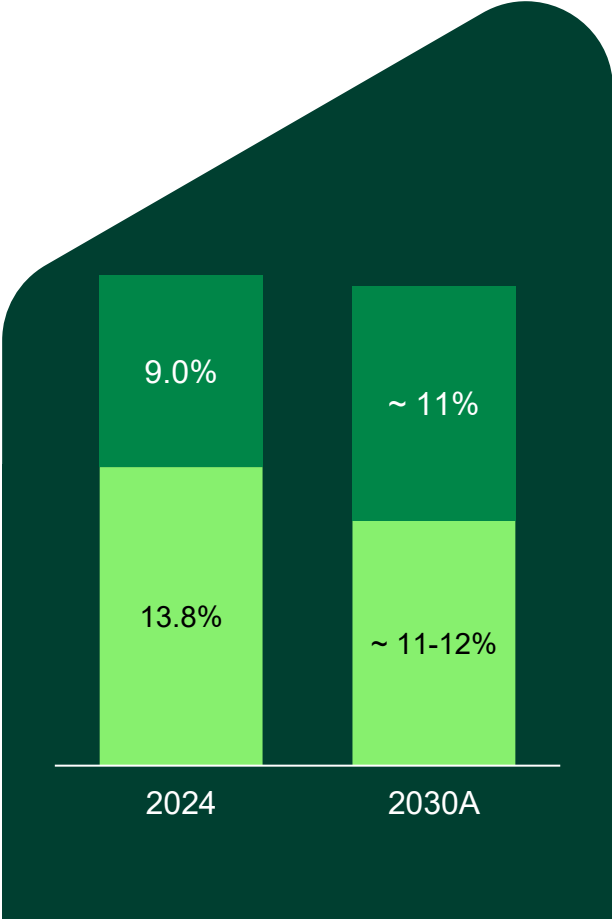

Reduced SG&A expense ratio projected

- **R&D expense ratio** is expected to increase to support sales growth
- **SG&A expense ratio** is expected to decrease by ~ 2 to 3 %-points due to below-average increase in selling costs and admin functions

■ R&D expense ratio
■ SG&A expense ratio

EBIT margin to benefit from higher business volume while increased R&D spend is covered by decline of SG&A expense ratio

How to achieve the targeted EBIT margin of 20 – 22%

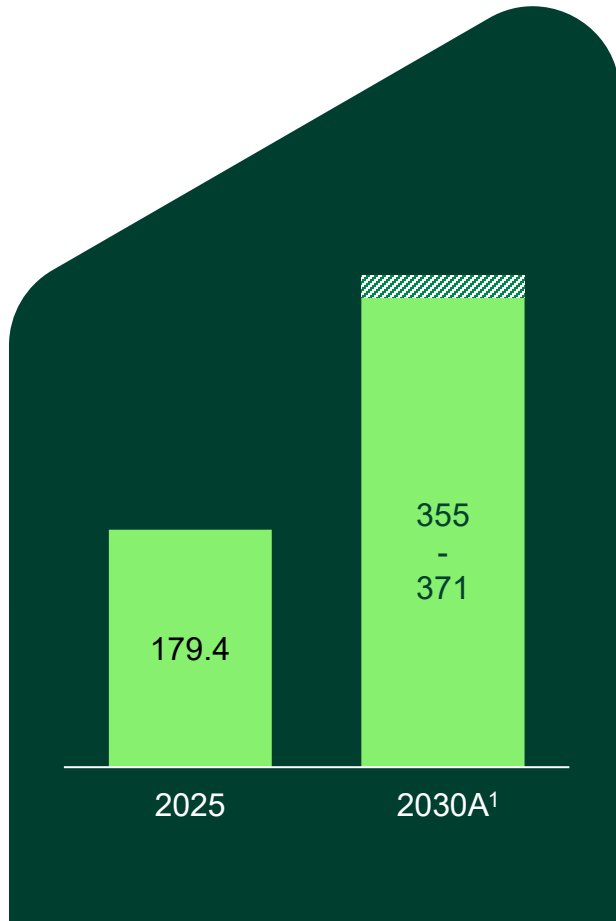

Benefiting from increase in gross profit

Gross profit has the potential to ~ **double** from 2025 to 2030, driven by larger business volume with improved profitability

¹ Gross profit is calculated based on the mid-point of the 2030 sales ambition.

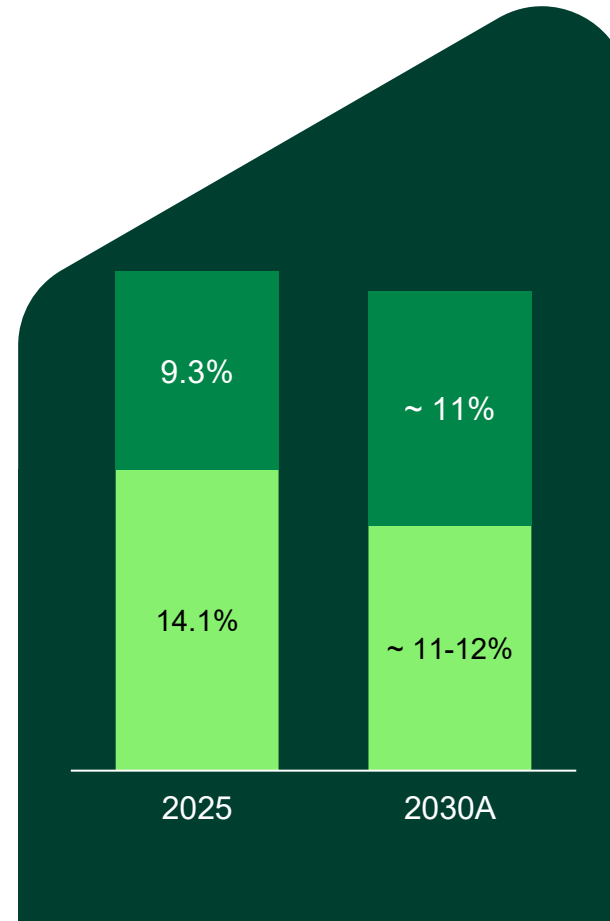

Reduced SG&A expense ratio projected

- **R&D expense ratio** is expected to increase to support sales growth
- **SG&A expense ratio** is expected to decrease by ~ 2 to 3 %-points due to below-average increase in selling costs and admin functions

■ R&D expense ratio
■ SG&A expense ratio

Our ambition is to take SUSS to a new financial level by 2030

	FY 2024	FY 2030A
Sales	€446.1 million	€750 – 900 million
Sales growth	46.6% (YoY)	9 to 13% (CAGR 2025 – 2030A ¹)
Gross profit margin (in %)	40%	43 to 45%
SG&A (in % of sales)	13.8%	~11 to 12%
R&D (in % of sales)	9.0%	~11%
EBIT margin (in %)	16.8%	20 to 22%
Free Cashflow	€25.3 million	~ €90 million
ROCE	36.8%	39 to 41%
CapEx	€7.6 million	~ €22 million (annual \varnothing 2026 – 2030)
Tax rate	33.1%	~28% ²

¹ The CAGR calculation is based on the midpoint of the 2025 sales forecast, i.e., € 490 million; ² The internal planning assumption for the tax rate is generally ~ 28%.

Our ambition is to take SUSS to a new financial level by 2030

	FY 2025	FY 2030A
Sales	€503.2 million	€750 – 900 million
Sales growth	12.6% (YoY)	8 to 12% (CAGR 2025 – 2030A)
Gross profit margin (in %)	35.7%	43 to 45%
SG&A (in % of sales)	14.1%	~11 to 12%
R&D (in % of sales)	9.3%	~11%
EBIT margin (in %)	13.1%	20 to 22%
Free Cashflow (continuing operations)	€-22.6 million	~ €90 million
ROCE	21.3%	39 to 41%
CapEx	€23.2 million	~ €22 million (annual \varnothing 2026 – 2030)
Tax rate	24.6%	~28% ¹

¹ The internal planning assumption for the tax rate is generally ~ 28%.

Investor Relations information

Conference and Roadshow Calendar

- **April 15, 2026**
Metzler Small Cap Days (IR only) | Frankfurt
- **May 19, 2026**
Kepler Cheuvreux Road Show | Paris
- **May 20, 2026**
UBS Technology, Media and Internet Conference | London
- **June 12, 2026**
ODDO BHF NextCap Forum | Virtual
- **August 26/27, 2026**
Jefferies Semiconductor & Tech Conference | Chicago
- **September 21, 2026**
Berenberg/Goldman Sachs German Corporate Conf. | Munich

There may be changes to the SUSS conference and roadshow schedule.

Financial Calendar

- **May 7, 2026**
Quarterly Statement Q1 2026
- **June 3, 2026**
Annual General Meeting, Munich
- **August 6, 2026**
Half-yearly financial Report
- **November 5, 2026**
Quarterly Statement Q3 2026

Disclaimer

This presentation contains forward-looking statements relating to the business, financial performance and earnings of SUSS MicroTec SE and its subsidiaries and associates.

Forward-looking statements are based on current plans, estimates, projections and expectations and are therefore subject to risks and uncertainties, most of which are difficult to estimate and which in general are beyond the control of SUSS MicroTec SE. Consequently, actual developments as well as actual earnings and performance may differ materially from those which explicitly or implicitly assumed in the forward-looking statements.

SUSS MicroTec SE does not intend or accept any obligation to publish updates of these forward-looking statements.

Thank you

Growing Innovation



Florian Mangold

Manager Investor Relations

Tel.: +49 89 32007-306

E-mail: florian.mangold@suss.com